



**Koordinierungsstelle
für IT-Standards**



Praxis der Standardisierung

E-Government und E-Justice –
Standardisierungsprozesse in tatsächlicher und rechtlicher Hinsicht

25. Deutscher EDV-Gerichtstag, 21. – 23.09.2016

Dr. Günther Diederich



Die Koordinierungsstelle für Standards in der IT

- Wir sind zuständig für den IT-Standard der IMK
- Wir entwickeln und betreiben Standards OSCI und XTA für den IT-Planungsrat
- Wir vertreten die öffentliche Verwaltung Deutschlands bei der europäischen Standardisierung der eRechnung
- Wir betreiben den Standard für Gewerbeanzeigen
- Wir bieten das XÖV Rahmenwerk für alles rund um Standards
- Wir unterstützen und beraten Standardisierungsvorhaben
- Wir bieten Produkte zur Entwicklung von Standards
- Wir informieren, schulen und beraten



Koordinierungsstelle
für IT-Standards

Was hat die KoSIT mit EGVP zu tun?

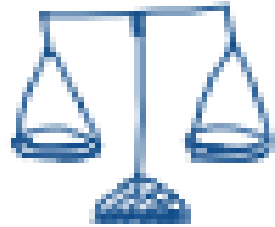

XJustiz



egvp.de



OSCI
Transport



XJustiz



egvp.de

hat zu XÖV beraten



KoSIT



betreibt OSCI



Was hat die KoSIT mit XJustiz zu tun?

Fachverfahren

XÖV **T**ransport **A**dapter

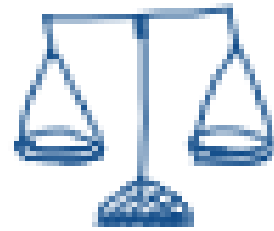
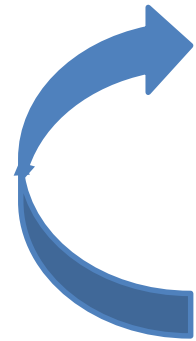

XJustiz

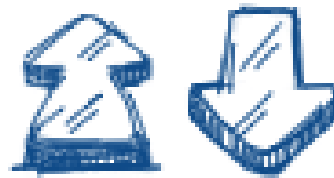

egvp.de



XTA



KoSIT

berät

betreibt

entwickelt

wartet & pflegt

Infrastruktur



XTA ist die einheitliche Schnittstelle im E-Government

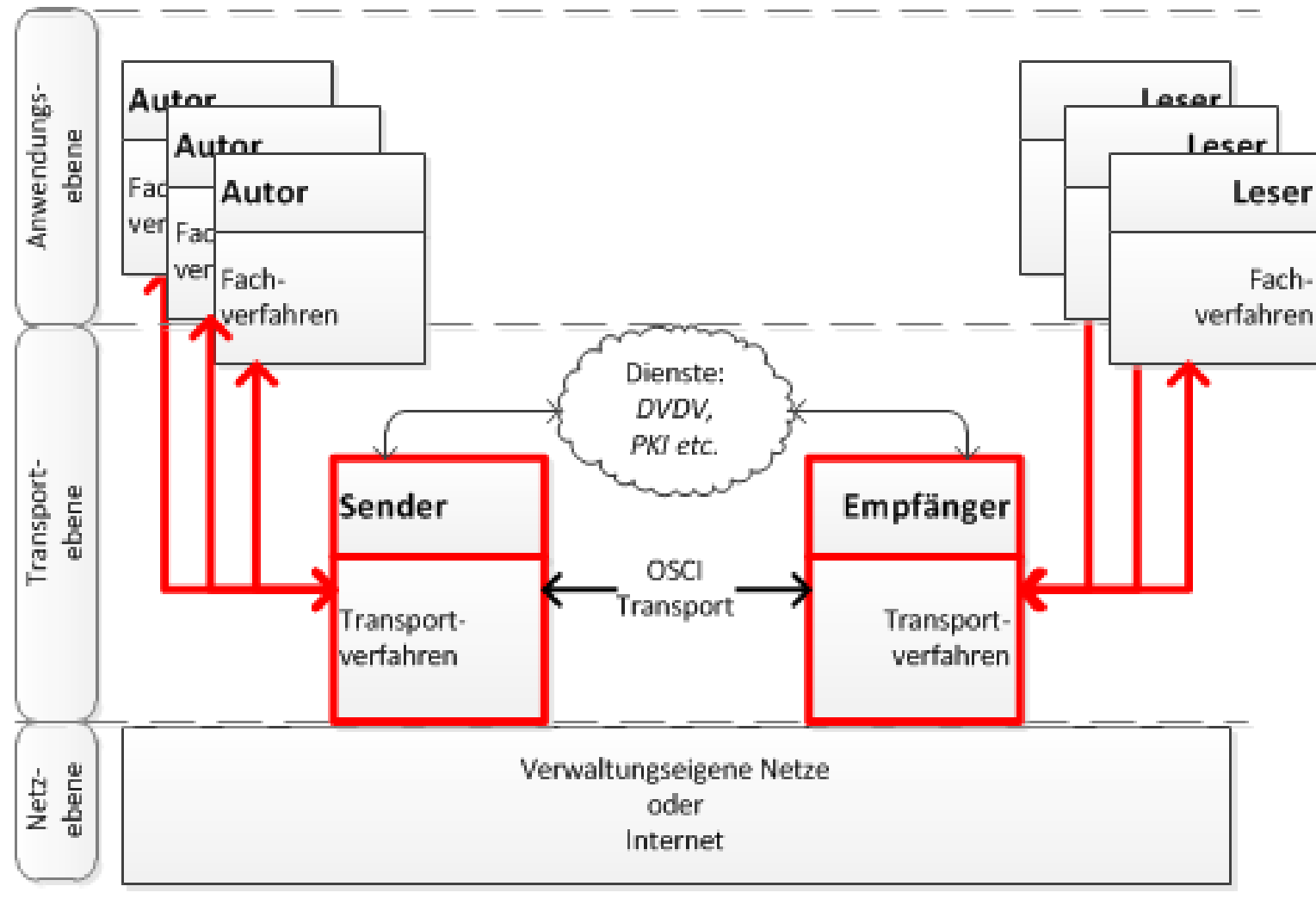



Organisatorische Zusammenhänge am Beispiel XTA/Justiz

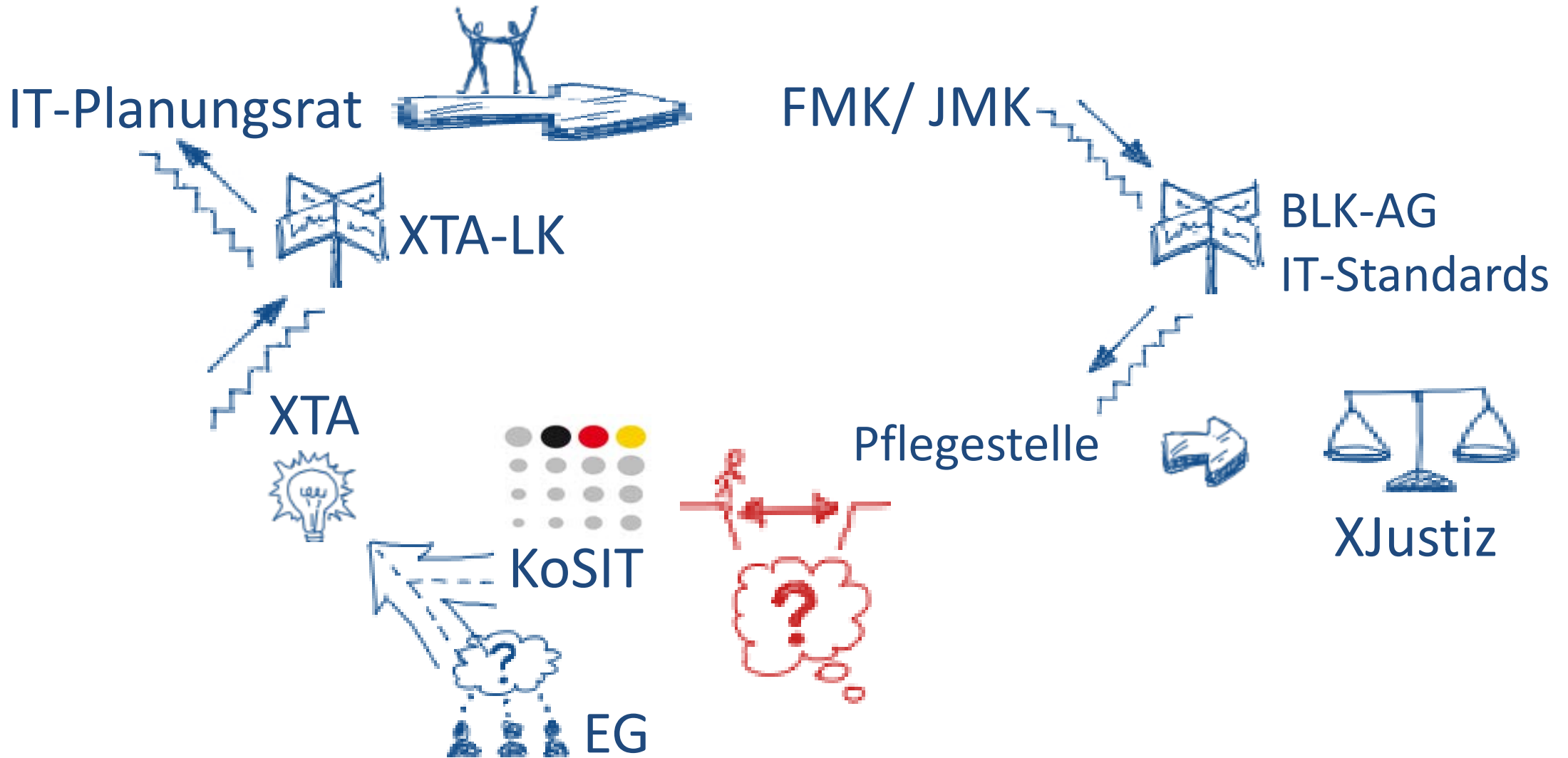



Kooperationsmöglichkeiten am Beispiel XTA/Justiz

KoopADV

IT-Planungsrat



FMK/ JMK

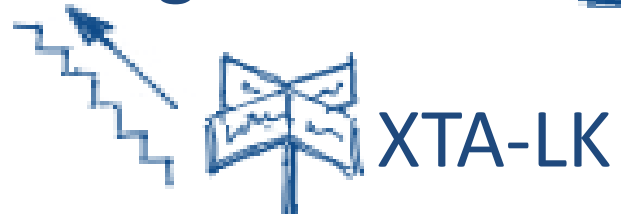

BLK-AG
IT-Standards



KoSIT

Pflegestelle



XJustiz



EG

egvp.de



Beispiel „Klingelknopf“

Bedarf e²P gemeldet, aber auch in eKP/forumSTAR gewünscht

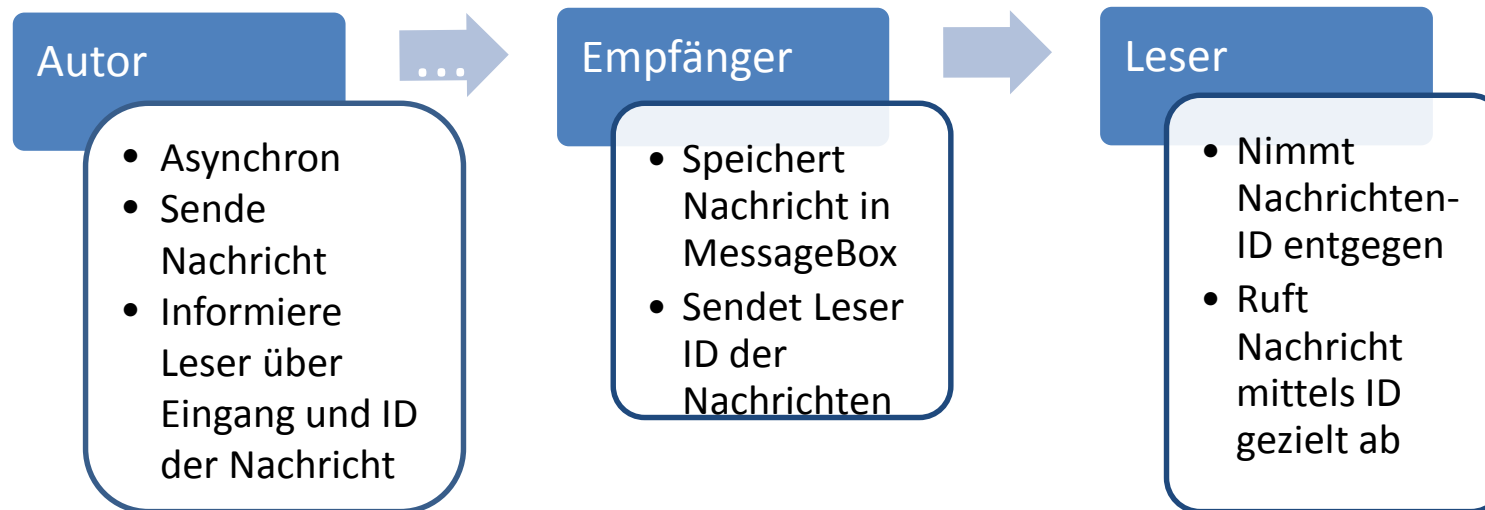



Bearbeitung und Qualitätssicherung von Änderungsanträgen

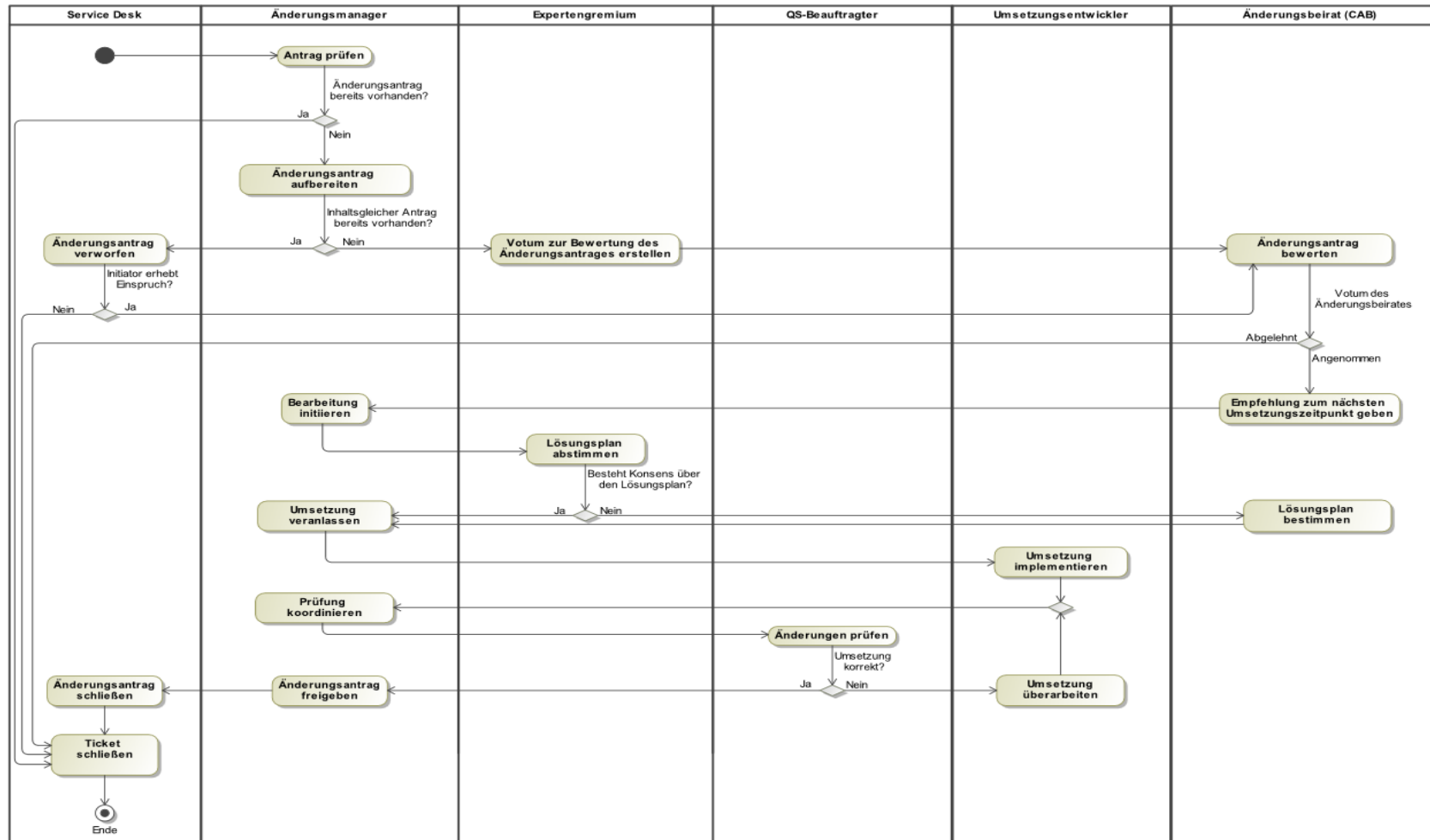



Herausforderungen in der Koordination - Ausgangslage



- Fiktives Beispiel „Standard 2017“
- Feste Terminfolge
- Veröffentlichung der Weiterentwicklung aus 2016
- Planung 2017
- Expertengremien 2017 (Anzahl nach Bedarf des Standards)



Beispiel 1: Hersteller brauchen Zeit für Tests



- Beispiel Interoperabilitätstests
- Technische Artefakte (z.B. WSDL, XSD) müssen ab einem bestimmten Zeitpunkt stabil bleiben
- Alle anderen Teile des Standards werden weiterentwickelt
- Drafts sind aufgrund des Änderungsmanagements verlässlich



Beispiel 2: Koordination mit anderen Standards, Projekten, AGs

Version 2016

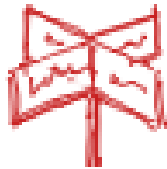

Standard 2017

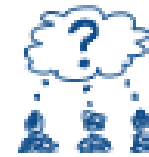

Freeze

Draft 2018

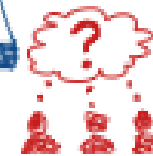

für alle betroffenen Standards, Projekte, AGs



Kontakt

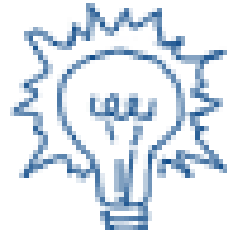

Koordinierungsstelle für IT-Standards (KoSIT)

Freie Hansestadt Bremen

Die Senatorin für Finanzen

Rudolf-Hilferding-Platz 1, 28195 Bremen

kosit@finanzen.bremen.de

www.xoev.de / www.osci.de